

DAMPER + MODULATION DIODE FOR VIDEO

MAIN PRODUCT CHARACTERISTICS

| | MODUL | DAMPER |
|-------------|-----------|-----------|
| $I_{F(AV)}$ | 3 A & 6 A | 5 A & 6 A |
| V_{RRM} | 600 V | 1500 V |
| t_{rr} | 50 ns | 135 ns |
| $V_F(max)$ | 1.5 V | 1.35 V |

FEATURES AND BENEFITS

- FULL KIT IN ONE PACKAGE
- HIGH BREAKDOWN VOLTAGE CAPABILITY
- VERY FAST RECOVERY DIODE
- SPECIFIED TURN ON SWITCHING CHARACTERISTICS
- LOW STATIC AND PEAK FORWARD VOLTAGE DROP FOR LOW DISSIPATION
- INSULATED VERSION:
Insulated voltage = 2500 V_{RMS}
Capacitance = 7 pF
- PLANAR TECHNOLOGY ALLOWING HIGH QUALITY AND BEST ELECTRICAL CHARACTERISTICS
- OUTSTANDING PERFORMANCE OF WELL PROVEN DTV AS DAMPER AND TURBOSWITCH™ AS MODULATION

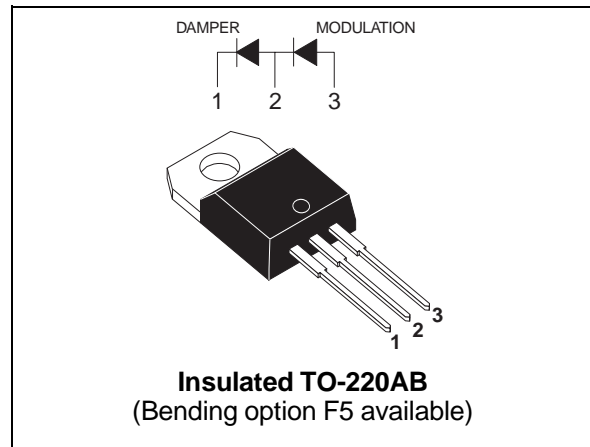

DESCRIPTION

High voltage semiconductor especially designed for horizontal deflection stage in standard and high resolution video display with E/W correction.

The insulated TO-220AB package includes both the DAMPER diode and the MODULATION diode. Assembled on automated line, it offers excellent insulating and dissipating characteristics, thanks to the internal ceramic insulation layer.

ABSOLUTE RATINGS (limiting values, per diode)

| Symbol | Parameter | | Value | | Unit | |
|-----------|--|--------------------------|---------------|--------|------|---|
| | | | MODUL | DAMPER | | |
| V_{RRM} | Repetitive peak reverse voltage | | 600 | 1500 | V | |
| I_{FSM} | Surge non repetitive forward current | tp = 10 ms sinusoidal | DMV16 | 50 | 50 | A |
| | | | DMV32 | 60 | 75 | |
| | | | DMV56 | 60 | 80 | |
| T_{stg} | Storage temperature range | | - 40 to + 150 | | °C | |
| T_j | Maximum operating junction temperature | | 150 | | | |

TURBOSWITCH is a trademark of STMicroelectronics

DMV series

THERMAL RESISTANCES

| Symbol | Parameter | Value | | | Unit |
|---------------|---|-------|-------|-------|------|
| | | DMV16 | DMV32 | DMV56 | |
| $R_{th(j-c)}$ | Damper junction to case | 5.3 | 4.8 | 3.6 | °C/W |
| $R_{th(j-c)}$ | Modulation junction to case | 6.5 | 5.3 | 5.3 | |
| $R_{th(c)}$ | Coupling | 0.2 | 0.2 | 0.2 | |
| $R_{th(j-c)}$ | Total as per full $I_{F(AV)}$ maximum ratings | 6.0 | 5.1 | 4.5 | |

STATIC ELECTRICAL CHARACTERISTICS OF THE DAMPER DIODES

| Symbol | Parameter | Test conditions | | Value | | | | Unit |
|----------|-------------------------|--------------------|-------|-----------------------|------|------------------------|------|------|
| | | | | T _j = 25°C | | T _j = 125°C | | |
| | | | | Typ. | Max. | Typ. | Max. | |
| V_F * | Forward voltage drop | $I_F = 5\text{ A}$ | DMV16 | | 1.6 | 1.0 | 1.5 | V |
| | | $I_F = 6\text{ A}$ | DMV32 | | 1.5 | 1.1 | 1.35 | |
| | | $I_F = 6\text{ A}$ | DMV56 | | 1.8 | 1.1 | 1.5 | |
| I_R ** | Reverse leakage current | $V_R = V_{RRM}$ | DMV16 | | 60 | 100 | 500 | µA |
| | | | DMV32 | | 100 | 100 | 1000 | |
| | | | DMV56 | | 100 | 100 | 1000 | |

Pulse test : * $t_p = 380\ \mu\text{s}$, $\delta < 2\%$

** $t_p = 5\ \text{ms}$, $\delta < 2\%$

To evaluate the maximum conduction losses of the DAMPER diode use the following equations :

$$\text{DMV16: } P = 1.14 \times I_{F(AV)} + 0.072 \times I_{F(RMS)}^2$$

$$\text{DMV32: } P = 1.069 \times I_{F(AV)} + 0.047 \times I_{F(RMS)}^2$$

$$\text{DMV56: } P = 1.15 \times I_{F(AV)} + 0.059 \times I_{F(RMS)}^2$$

STATIC ELECTRICAL CHARACTERISTICS OF THE MODULATION DIODE

| Symbol | Parameter | Test conditions | | Value | | | | Unit |
|----------|-------------------------|----------------------|-------|-----------------------|------|------------------------|------|------|
| | | | | T _j = 25°C | | T _j = 125°C | | |
| | | | | Typ. | Max. | Typ. | Max. | |
| V_F * | Forward voltage drop | $I_F = 3\text{ A}$ | DMV16 | | 1.4 | 1 | 1.3 | V |
| | | $I_F = 5\text{ A}$ | DMV32 | | 1.75 | 1.2 | 1.5 | |
| | | $I_F = 5\text{ A}$ | DMV56 | | 1.75 | 1.2 | 1.5 | |
| I_R ** | Reverse leakage current | $V_R = 480\text{ V}$ | DMV16 | | 20 | 150 | 500 | µA |
| | | | DMV32 | | 100 | 600 | 2000 | |
| | | | DMV56 | | 100 | 600 | 2000 | |

Pulse test : * $t_p = 380\ \mu\text{s}$, $\delta < 2\%$

** $t_p = 5\ \text{ms}$, $\delta < 2\%$

To evaluate the maximum conduction losses of the MODULATION diode use the following equations :

$$\text{DMV16: } P = 1.06 \times I_{F(AV)} + 0.08 \times I_{F(RMS)}^2$$

$$\text{DMV32: } P = 1.15 \times I_{F(AV)} + 0.07 \times I_{F(RMS)}^2$$

$$\text{DMV56: } P = 1.15 \times I_{F(AV)} + 0.07 \times I_{F(RMS)}^2$$

RECOVERY CHARACTERISTICS OF THE DAMPER DIODE

| Symbol | Parameter | Test conditions | | | Value | | Unit |
|-----------------|-----------------------|--|-----------------------|-------|-------|------|------|
| | | | | | Typ. | Max. | |
| t _{rr} | Reverse recovery time | I _F = 100mA I _R = 100mA I _{RR} = 10mA | T _j = 25°C | DMV16 | 1500 | | ns |
| | | | | DMV32 | 850 | | |
| | | | | DMV56 | 750 | | |
| t _{rr} | Reverse recovery time | I _F = 1A dI _F /dt = -50A/μs V _R = 30V | T _j = 25°C | DMV16 | 200 | 300 | ns |
| | | | | DMV32 | 130 | 175 | |
| | | | | DMV56 | 110 | 135 | |

RECOVERY CHARACTERISTICS OF THE MODULATION DIODE

| Symbol | Parameter | Test conditions | | | Value | | Unit |
|-----------------|-----------------------|--|-----------------------|-------|-------|------|------|
| | | | | | Typ. | Max. | |
| t _{rr} | Reverse recovery time | I _F = 100mA I _R = 100mA I _{RR} = 10mA | T _j = 25°C | DMV16 | 210 | 650 | ns |
| | | | | DMV32 | 110 | 350 | |
| | | | | DMV56 | 110 | 350 | |
| t _{rr} | Reverse recovery time | I _F = 1A dI _F /dt = -50A/μs V _R = 30V | T _j = 25°C | DMV16 | | 95 | ns |
| | | | | DMV32 | | 50 | |
| | | | | DMV56 | | 50 | |

TURN-ON SWITCHING CHARACTERISTICS OF THE DAMPER DIODE

| Symbol | Parameter | Test conditions | | | Value | | Unit |
|-----------------|-----------------------|---|------------------------|-------|-------|------|------|
| | | | | | Typ. | Max. | |
| t _{fr} | Forward recovery time | I _F = 6A dI _F /dt = 80A/μs V _{FR} = 3V | T _j = 100°C | DMV16 | 350 | | ns |
| | | | | DMV32 | 570 | | |
| | | | | DMV56 | 350 | | |
| V _{FP} | Peak forward voltage | I _F = 6A dI _F /dt = 80A/μs | T _j = 100°C | DMV16 | 25 | 34 | V |
| | | | | DMV32 | 21 | 28 | |
| | | | | DMV56 | 19 | 26 | |

TURN-ON SWITCHING CHARACTERISTICS OF THE MODULATION DIODE

| Symbol | Parameter | Test conditions | | | Value | | Unit |
|-----------------|-----------------------|---|------------------------|-------|-------|------|------|
| | | | | | Typ. | Max. | |
| t _{fr} | Forward recovery time | I _F = 3A dI _F /dt = 80A/μs V _{FR} = 3V | T _j = 100°C | DMV16 | | 500 | ns |
| | | | | DMV32 | | 300 | |
| | | | | DMV56 | | 300 | |
| V _{FP} | Peak forward voltage | I _F = 3A dI _F /dt = 80A/μs | T _j = 100°C | DMV16 | | 8 | V |
| | | | | DMV32 | | 10 | |
| | | | | DMV56 | | 10 | |

ORDERING INFORMATION

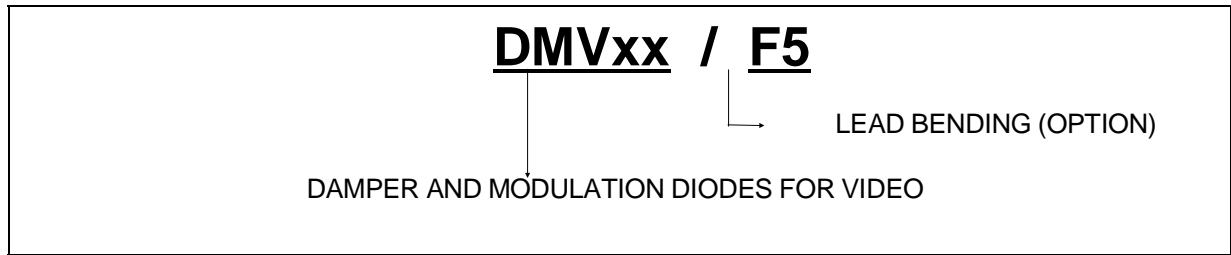

Fig. 1-1: Power dissipation versus peak forward current (triangular waveform, $\delta=0.45$) (damper diode.)

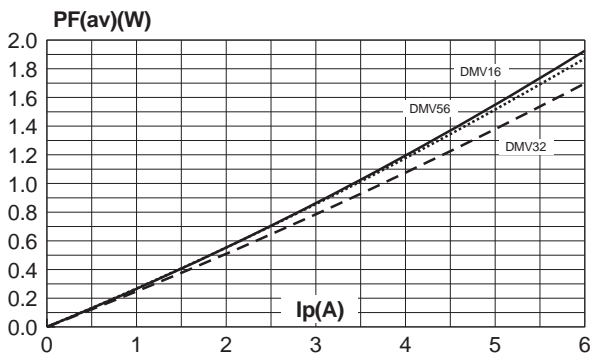

Fig. 1-2: Power dissipation versus peak forward current (triangular waveform, $\delta=0.45$) (modulation diode)

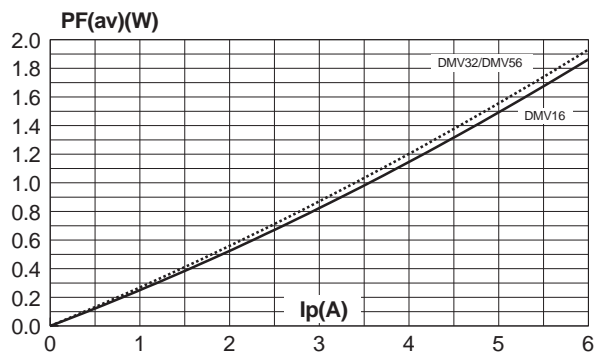

Fig. 2-1: Average forward current versus ambient temperature (damper diode).

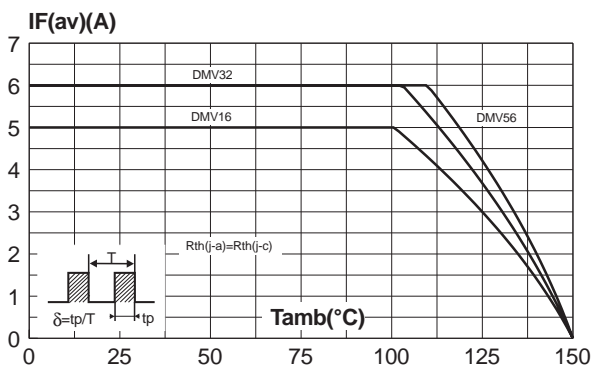

Fig. 2-2: Average forward current versus ambient temperature (modulation diode).

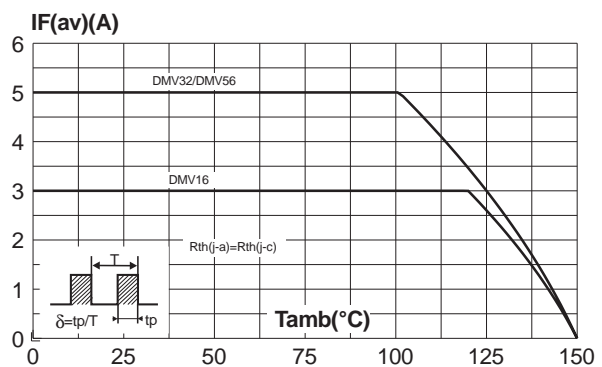

Fig. 3-1: Forward voltage drop versus forward current (damper diode) DMV16.

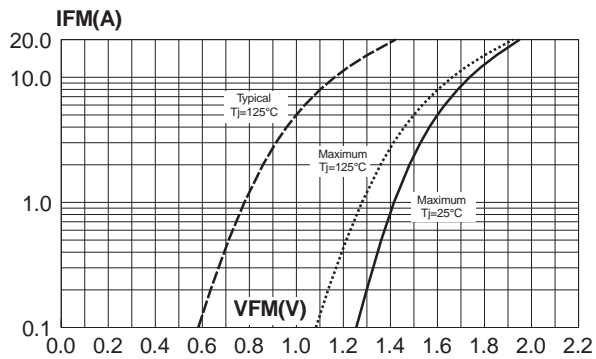

Fig. 3-2: Forward voltage drop versus forward current (damper diode) DMV32.

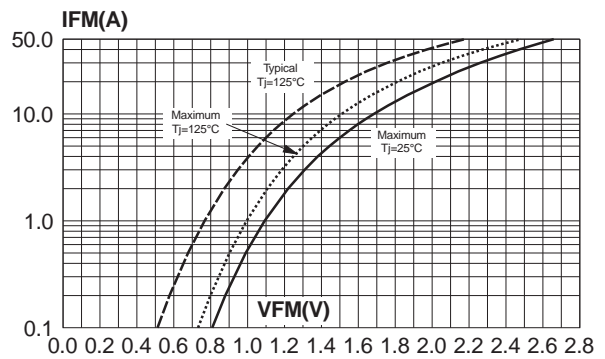

Fig. 3-3: Forward voltage drop versus forward current (damper diode) DMV56.

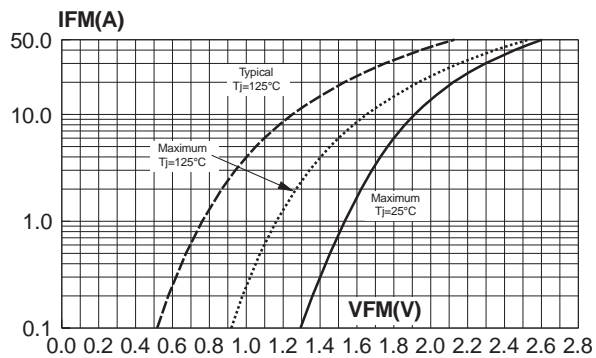

Fig. 3-4: Forward voltage drop versus forward current (modulation diode) DMV16.

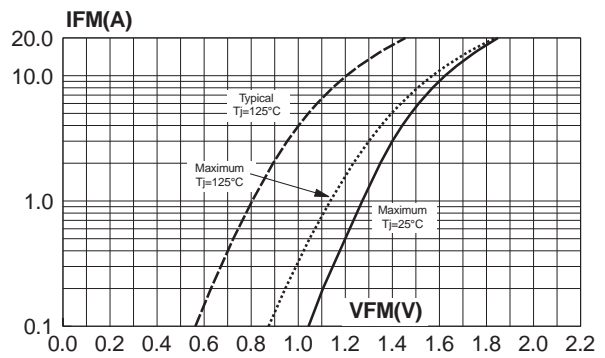

Fig. 3-5: Forward voltage drop versus forward current (modulation diode) DMV32 and DMV56.

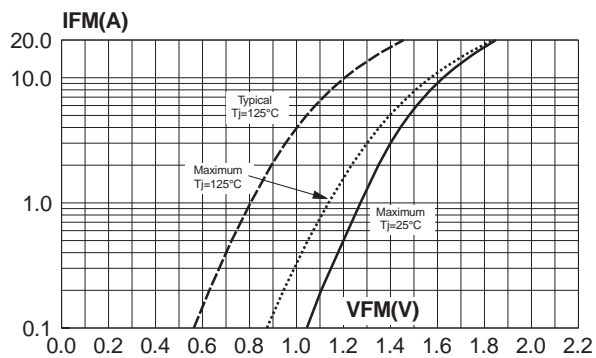
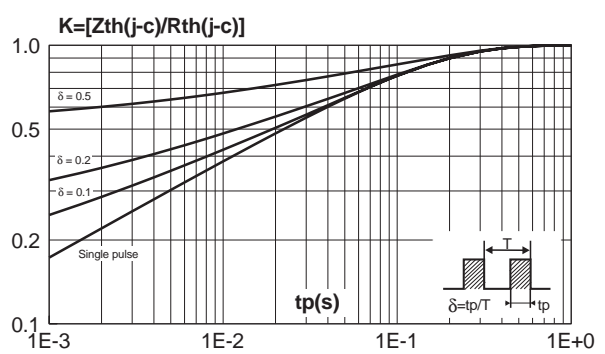

Fig. 4: Relative variation of thermal impedance junction to case versus pulse duration.



DMV series

Fig. 5-1: Non repetitive surge peak forward current versus overload duration (damper diode).

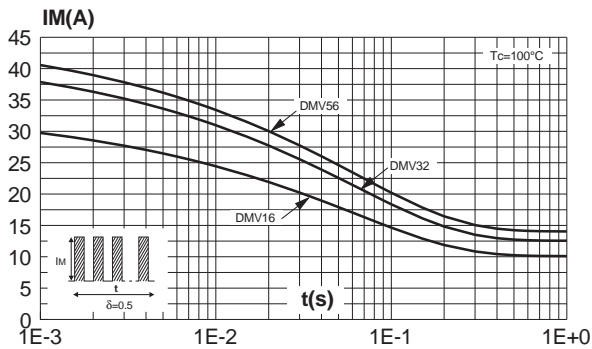

Fig. 5-2: Non repetitive surge peak forward current versus overload duration (modulation diode).

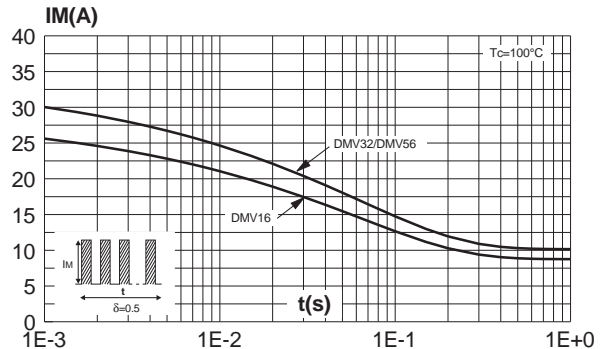

Fig. 6-1: Reverse recovery charges versus dI_F/dt (damper diode).

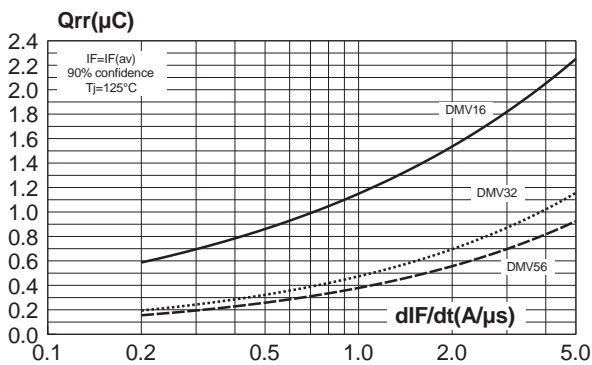

Fig. 6-2: Reverse recovery charges versus dI_F/dt (modulation diode).

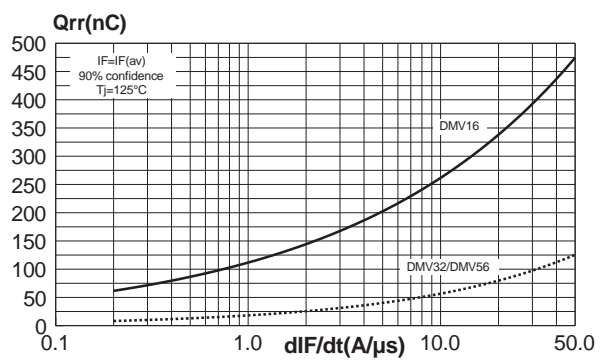

Fig. 7-1: Reverse recovery current versus dI_F/dt (damper diode).

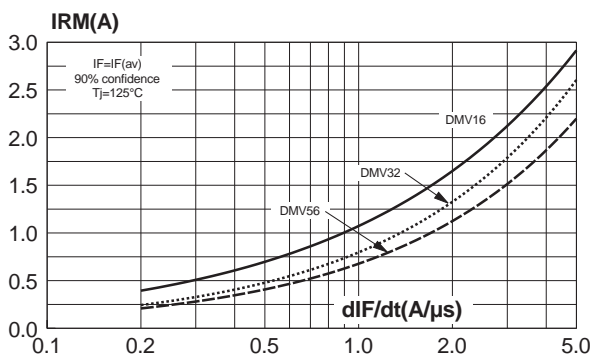

Fig. 7-2: Reverse recovery current versus dI_F/dt (modulation diode).

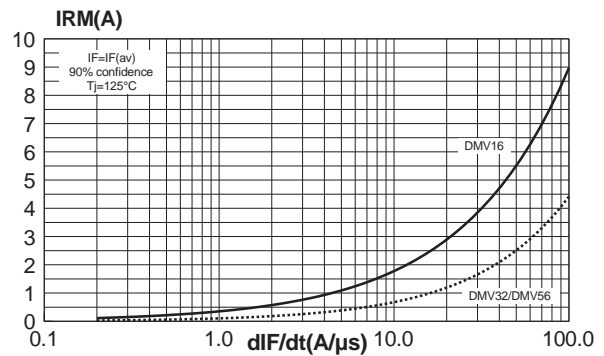

Fig. 8-1: Transient peak forward voltage versus dI_F/dt (damper diode).

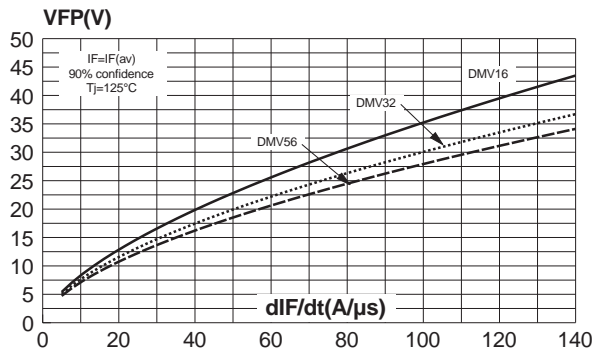

Fig. 8-2: Transient peak forward voltage versus dI_F/dt (modulation diode).

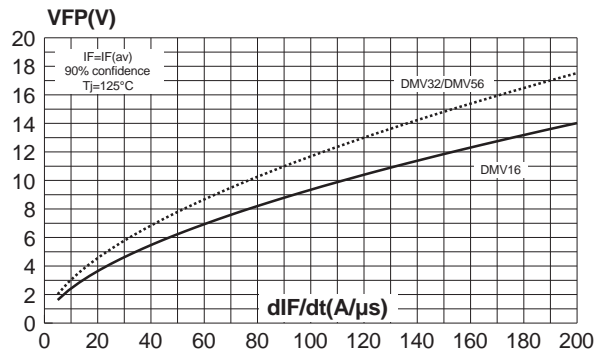

Fig. 9-1: Forward recovery time versus dI_F/dt (damper diode).

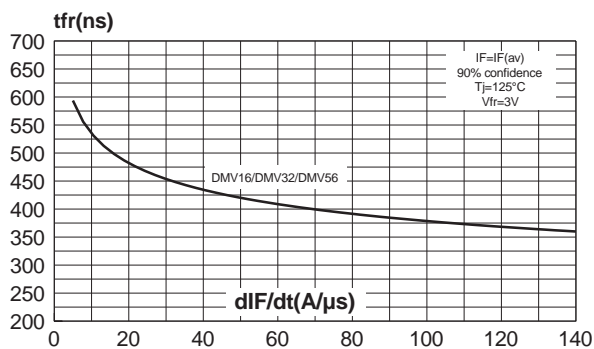

Fig. 9-2: Forward recovery time versus dI_F/dt (modulation diode).

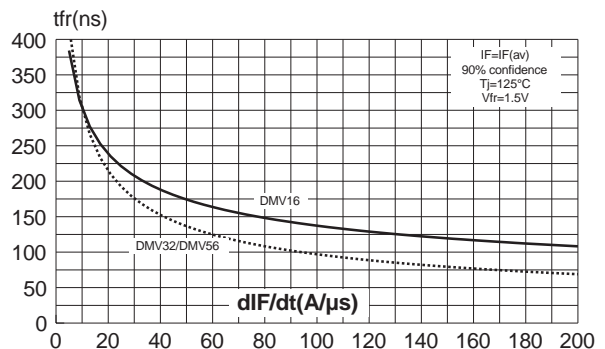

Fig. 10: Dynamic parameters versus junction temperature (damper & modulation diodes).

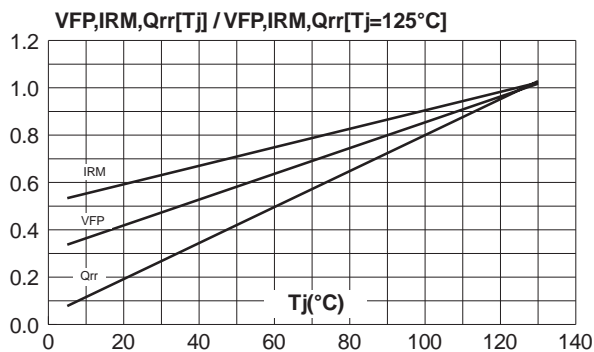
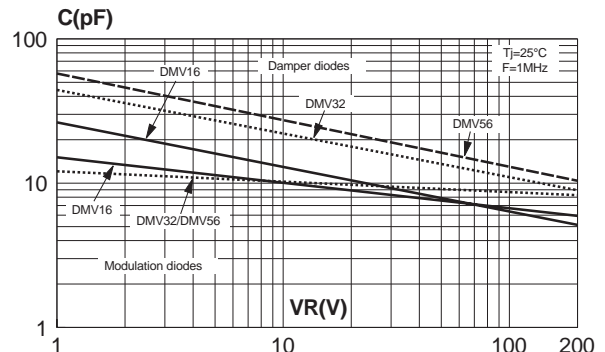

Fig. 11: Junction capacitance versus reverse voltage applied (typical values).



DMV series

PACKAGE MECHANICAL DATA TO-220AB F5 OPTION

| REF. | DIMENSIONS | | | |
|------|-------------|-------|------------|-------|
| | Millimeters | | Inches | |
| | Min. | Max. | Min. | Max. |
| A | 15.20 | 15.90 | 0.598 | 0.625 |
| a1 | 24.16 | 26.90 | 0.951 | 1.059 |
| a3 | 1.65 | 2.41 | 0.064 | 0.094 |
| B | 10.00 | 10.40 | 0.393 | 0.409 |
| b1 | 0.61 | 0.88 | 0.024 | 0.034 |
| b2 | 1.23 | 1.32 | 0.048 | 0.051 |
| C | 4.40 | 4.60 | 0.173 | 0.181 |
| c1 | 0.49 | 0.70 | 0.019 | 0.027 |
| c2 | 2.40 | 2.72 | 0.094 | 0.107 |
| e | 2.40 | 2.70 | 0.094 | 0.106 |
| F | 6.20 | 6.60 | 0.244 | 0.259 |
| l | 3.75 | 3.85 | 0.147 | 0.151 |
| L | 2.65 | 2.95 | 0.104 | 0.116 |
| l2 | 1.14 | 1.70 | 0.044 | 0.066 |
| l3 | 1.14 | 1.70 | 0.044 | 0.066 |
| l4 | 15.80 | 16.80 | 0.622 | 0.661 |
| | 16.40 typ. | | 0.645 typ. | |
| M1 | 2.92 | 3.30 | 0.114 | 0.129 |
| R1 | 1.40 typ. | | 0.055 typ. | |
| R2 | 1.40 typ. | | 0.055 typ. | |

PRINTED CIRCUIT LAYOUT FOR F5 LAYOUT

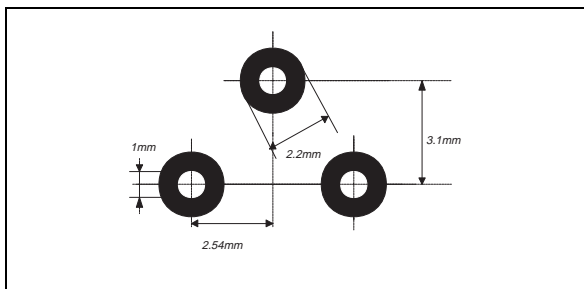

- cooling method: by conduction (c)
- Recommended torque value: 0.8 m.N.
- Maximum torque value: 1 m.N.

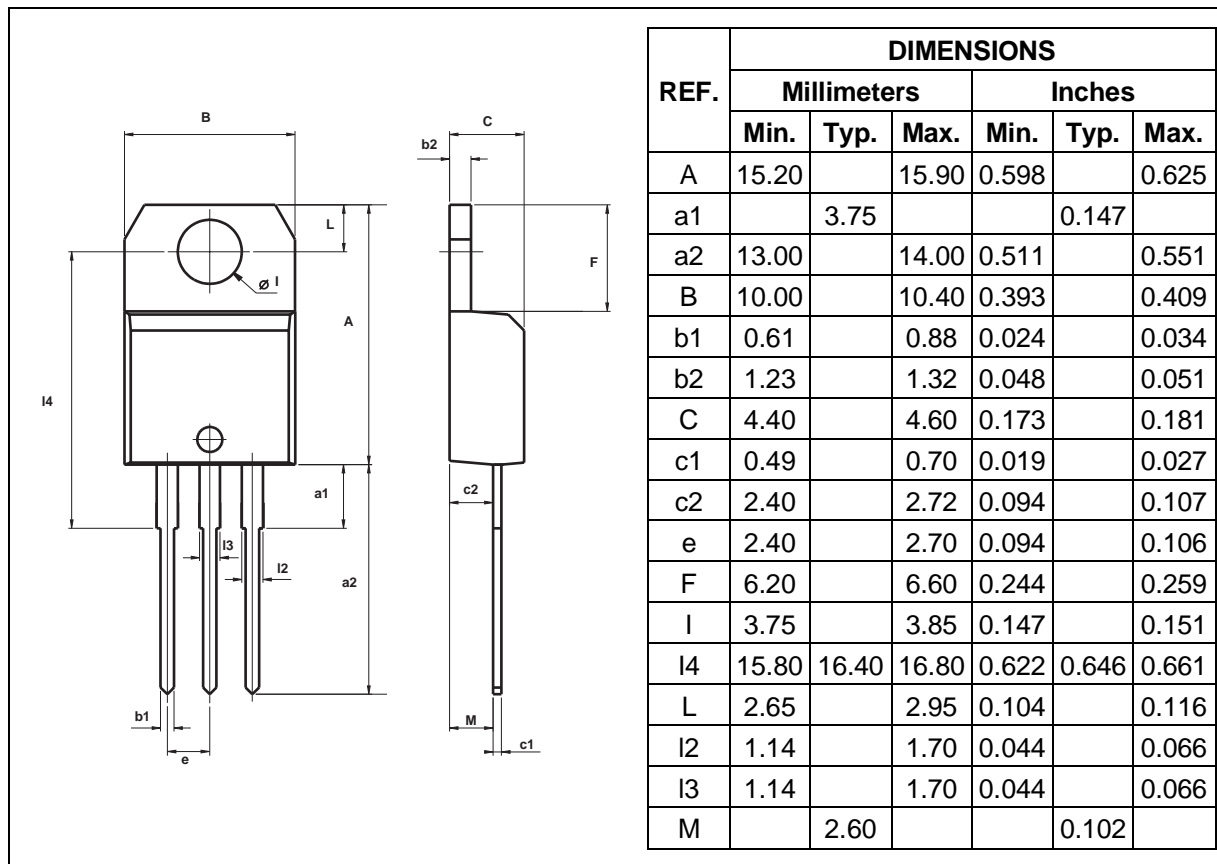
PACKAGE MECHANICAL DATA
 TO-220AB

- cooling method: by conduction (c)
- Recommended torque value: 0.8 m.N.
- Maximum torque value: 1 m.N.

| Type | Marking | Package | Weight | Base qty | Delivery mode |
|-------------------|---------|----------|--------|----------|---------------|
| DMV16 DMV16/F5 | DMV16 | TO-220AB | 2.2 g. | 50 | Tube |
| DMV32 DMV32/F5 | DMV32 | TO-220AB | 2.2 g. | 50 | Tube |
| DMV56 DMV56/F5 | DMV56 | TO-220AB | 2.2 g. | 50 | Tube |

- Epoxy meets UL94, V0

Information furnished is believed to be accurate and reliable. However, STMicroelectronics assumes no responsibility for the consequences of use of such information nor for any infringement of patents or other rights of third parties which may result from its use. No license is granted by implication or otherwise under any patent or patent rights of STMicroelectronics. Specifications mentioned in this publication are subject to change without notice. This publication supersedes and replaces all information previously supplied. STMicroelectronics products are not authorized for use as critical components in life support devices or systems without express written approval of STMicroelectronics.

The ST logo is a registered trademark of STMicroelectronics

© 1999 STMicroelectronics - Printed in Italy - All rights reserved.

STMicroelectronics GROUP OF COMPANIES

Australia - Brazil - China - Finland - France - Germany - Hong Kong - India - Italy - Japan - Malaysia
 Malta - Morocco - Singapore - Spain - Sweden - Switzerland - United Kingdom - U.S.A.

<http://www.st.com>