

# TB2906HQ

## Maximum Power 43 W BTL × 4-ch Audio Power IC

The TB2906HQ is 4-ch BTL audio amplifier for car audio applications.

This IC can generate higher power:  $P_{OUT\ MAX} = 43\ W$  as it includes the pure complementary P-ch and N-ch DMOS output stage.

It is designed to yield low distortion ratio for 4-ch BTL audio power amplifier, built-in standby function, muting function, and various kinds of protectors.

Additionally, Off-set detector is built in.

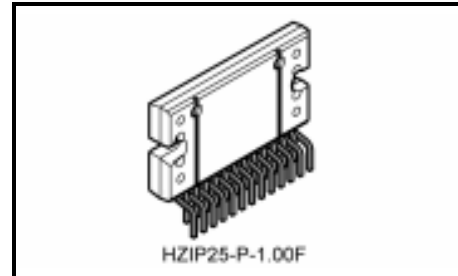

Weight: 7.7 g (typ.)

## Features

- High power output
  - :  $P_{OUT\ MAX} (1) = 43\ W$  (typ.)  
 $P (V_{CC} = 14.4\ V, f = 1\ kHz, JEITA\ max, R_L = 4\ \Omega)$
  - :  $P_{OUT\ MAX} (2) = 39\ W$  (typ.)  
 $(V_{CC} = 13.7\ V, f = 1\ kHz, JEITA\ max, R_L = 4\ \Omega)$
  - :  $P_{OUT} (1) = 26\ W$  (typ.)  
 $(V_{CC} = 14.4\ V, f = 1\ kHz, THD = 10\%, R_L = 4\ \Omega)$
  - :  $P_{OUT} (2) = 23\ W$  (typ.)  
 $(V_{CC} = 13.2\ V, f = 1\ kHz, THD = 10\%, R_L = 4\ \Omega)$
- Low distortion ratio:  $THD = 0.015\%$  (typ.)  
 $(V_{CC} = 13.2\ V, f = 1\ kHz, P_{OUT} = 5\ W, R_L = 4\ \Omega)$
- Low noise:  $V_{NO} = 180\ \mu V_{rms}$  (typ.)  
 $(V_{CC} = 13.2\ V, R_g = 0\ \Omega, BW = 20\ Hz\ to\ 20\ kHz, R_L = 4\ \Omega)$
- Built-in standby switch function (pin 4)
- Built-in muting function (pin 22)
- Built-in Off-set detection function (pin 25)
- Built-in various protection circuits:  
Thermal shut down, overvoltage, out to GND, out to VCC, out to out short
- Operating supply voltage:  $V_{CC} (opr) = 9\ to\ 18\ V (R_L = 4\ \Omega)$

Note 1: Since this device's pins have a low withstanding voltage, please handle it with care.

Note 2: Install the product correctly. Otherwise, it may result in break down, damage and/or degradation to the product or equipment.

Note 3: These protection functions are intended to avoid some output short circuits or other abnormal conditions temporarily. These protect functions do not warrant to prevent the IC from being damaged. In case of the product would be operated with exceeded guaranteed operating ranges, these protection features may not operate and some output short circuits may result in the IC being damaged.

## Block Diagram

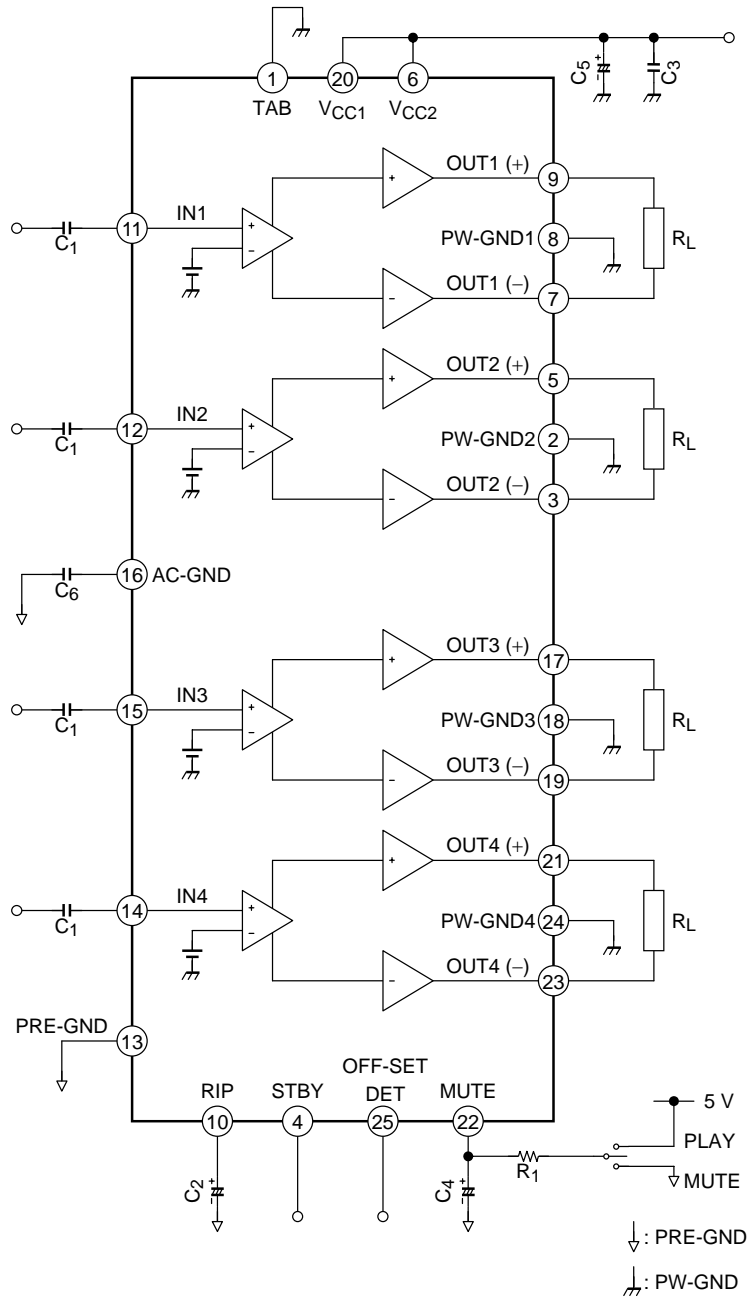

Note: Some of the functional blocks, circuits, or constants in the block diagram may be omitted or simplified for explanatory purpose.

**Caution and Application Method (Description is made only on the single channel)**

**1. Voltage Gain Adjustment**

This IC has no NF (negative feedback) Pins. Therefore, the voltage gain can not be adjusted, but it makes the device a space and total costs saver.

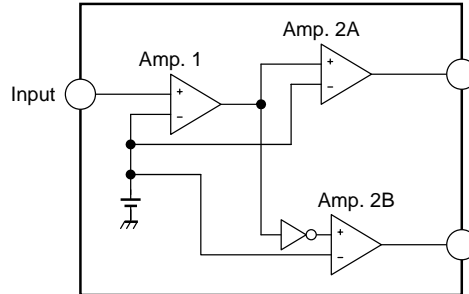

**Figure 1 Block Diagram**

The voltage gain of amp.1 :  $G_{V1} = 8\text{dB}$

The voltage gain of amp.2A, B :  $G_{V2} = 20\text{dB}$

The voltage gain of BTL connection:  $G_V (\text{BTL}) = 6\text{dB}$

Therefore, the total voltage gain is decided by expression below.

$$G_V = G_{V1} + G_{V2} + G_V (\text{BTL}) = 8 + 20 + 6 = 34\text{dB}$$

**2. Standby SW Function (pin 4)**

By means of controlling pin 4 (standby pin) to High and Low, the power supply can be set to ON and OFF. The threshold voltage of pin 4 is set at about  $3 V_{BE}$  (typ.), and the power supply current is about  $2 \mu\text{A}$  (typ.) in the standby state.

**Control Voltage of Pin 4:  $V_{SB}$**

Stand-by	Power	$V_{SB}$ (V)
ON	OFF	0 to 1.5
OFF	ON	3.5 to 6 V

When changing the time constant of pin 4, check the pop noise.

**Advantage of Standby SW**

- (1) Since  $V_{CC}$  can directly be controlled to ON or OFF by the microcomputer, the switching relay can be omitted.
- (2) Since the control current is microscopic, the switching relay of small current capacity is satisfactory for switching.

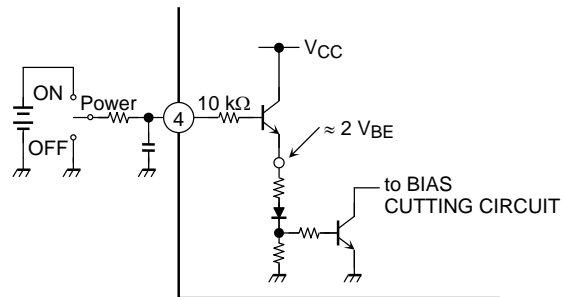

**Figure 2 With pin 4 set to High, Power is turned ON**

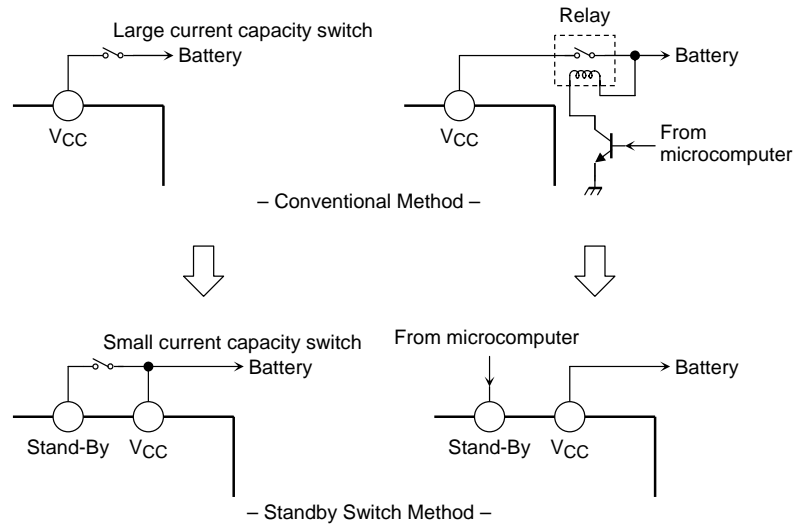

Figure 3

3. Muting Function (pin 22)

Audio muting function is enabled when pin 22 is Low. When the time constant of the muting function is determined by  $R_1$  and  $C_4$ , it should take into account the pop noise. The pop noise, which is generated when the power or muting function is turned ON/OFF, will vary according to the time constant. (Refer to Figure 4 and Figure 5.)

The pin 22 is designed to operate off 5 V so that the outside pull-up resistor  $R_1$  is determined on the basic of this value:

ex) When control voltage is changed in to 6 V from 5 V.  
 $6 \text{ V} / 5 \text{ V} \times 47 \text{ k} = 56 \text{ k}$

Additionally, as the  $V_{CC}$  is rapidly falling, the IC internal low voltage muting operates to eliminate the large pop noise basically.

The low voltage muting circuit pull 200  $\mu\text{A}$  current into the IC so that the effect of the internal low voltage muting does not become enough if the  $R_1$  is too small value.

To obtain enough operation of the internal low voltage muting, a series resistor,  $R_1$  at pin 22 should be 47  $\text{k}\Omega$  or more.

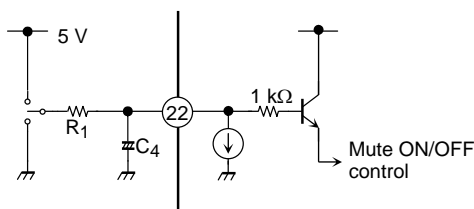

Figure 4 Muting Function

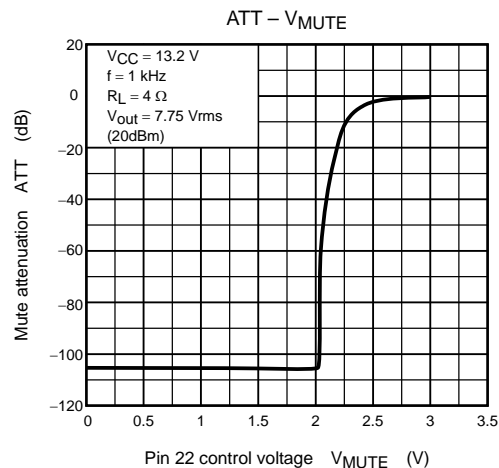

Figure 5 Mute Attenuation –  $V_{MUTE}$  (V)

4. Off-set detection function

In case of Appearing output offset voltage by Generating a Large Leakage Current on the input Capacitor etc.

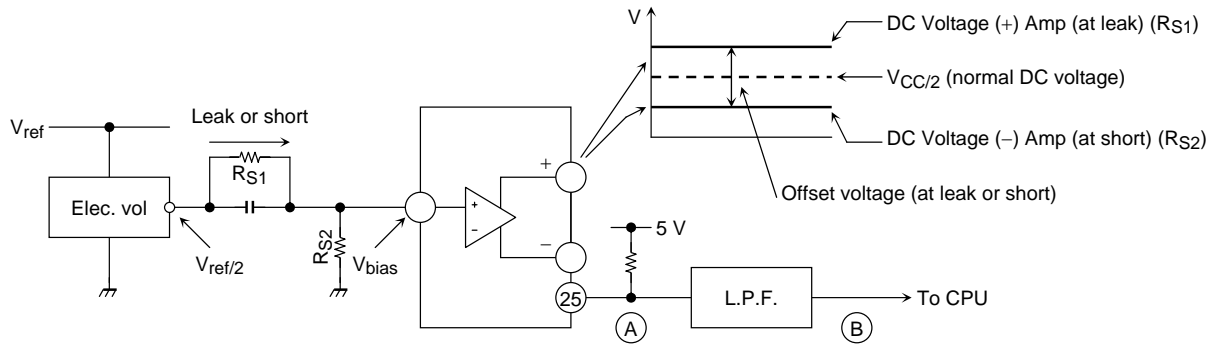

Figure 6 Application and Detection Mechanism

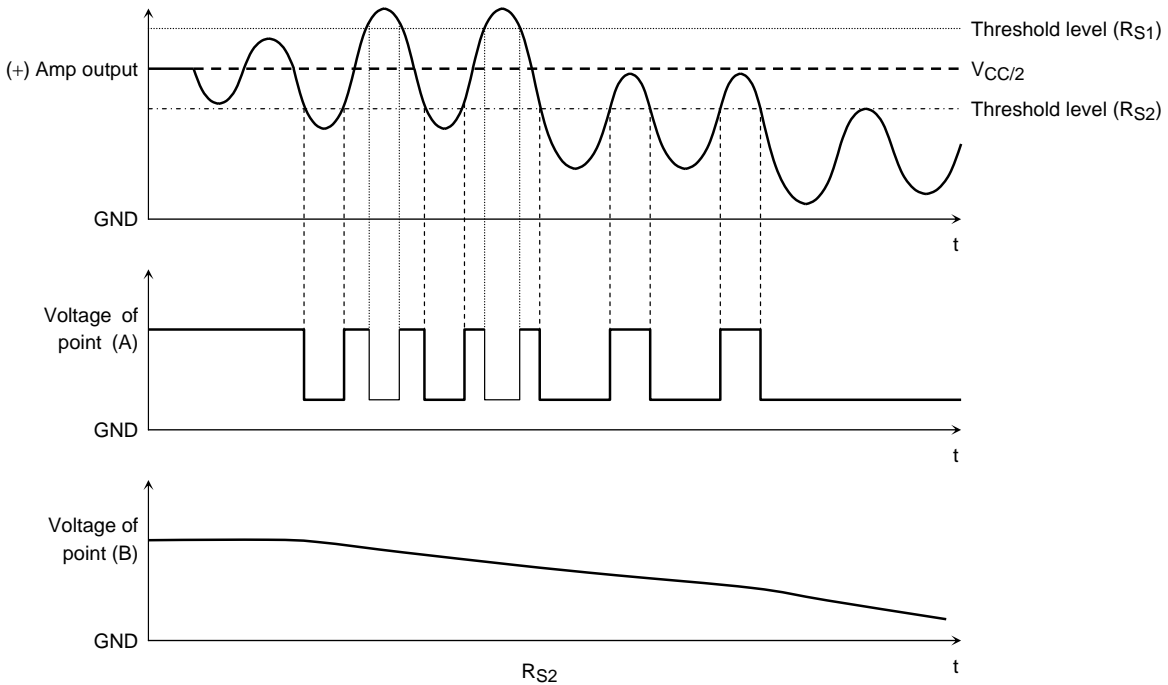

Figure 7 Wave Form

## 5. Prevention of speaker burning accident (in case of rare short circuit of speaker)

When the direct current resistance between OUT+ and OUT- terminal becomes  $1\ \Omega$  or less and output current over 4 A flows, this IC makes a protection circuit operate and suppresses the current into a speaker. This system makes the burning accident of the speaker prevent as below mechanism.

<The guess mechanism of a burning accident of the speaker>

Abnormal output offset voltage (voltage between OUT+ and OUT-) over 4 V is made by the external circuit failure.(Note 1)

↓

The speaker impedance becomes  $1\ \Omega$  or less as it is in a rare short circuit condition.

↓

The current more than 4 A flows into the speaker and the speaker is burned.

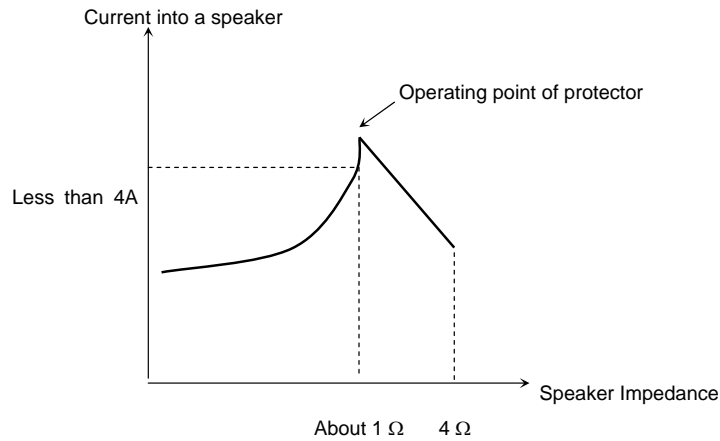

**Figure 8**

Note 1: It is appeared by biased input DC voltage  
(For example, large leakage of the input capacitor, short-circuit between copper patterns of PCB.)

**6. Pop Noise Suppression**

Since the AC-GND pin (pin 16) is used as the NF pin for all amps, the ratio between the input capacitance (C1) and the AC-to-GND capacitance (C6) should be 1:4.

Also, if the power is turned OFF before the C1 and C6 batteries have been completely charged, pop noise will be generated because of the DC input unbalance.

To counteract the noise, it is recommended that a longer charging time be used for C2 as well as for C1 and C6. Note that the time which audio output takes to start will be longer, since the C2 makes the muting time (the time from when the power is turned ON to when audio output starts) is fix.

The pop noise which is generated when the muting function is turned ON/OFF will vary according to the time constant of C4.

The greater the capacitance, the lower the pop noise. Note that the time from when the mute control signal is applied to C4 to when the muting function is turned ON/OFF will be longer.

**7. External Component Constants**

Component Name	Recommended Value	Purpose	Effect		Notes
			Lower than recommended value	Higher than recommended value	
C1	0.22 $\mu$ F	To eliminate DC	Cut-off frequency is increased	Cut-off frequency is reduced	Pop noise is generated when V <sub>CC</sub> is ON
C2	10 $\mu$ F	To reduce ripple	Powering ON/OFF is faster	Powering ON/OFF takes longer	
C3	0.1 $\mu$ F	To provide sufficient oscillation margin	Reduces noise and provides sufficient oscillation margin		
C4	1 $\mu$ F	To reduce pop noise	High pop noise. Duration until muting function is turned ON/OFF is short	Low pop noise. Duration until muting function is turned ON/OFF is long	
C5	3900 $\mu$ F	Ripple filter	Power supply ripple filtering		
C6	1 $\mu$ F	NF for all outputs	Pop noise is suppressed when C1:C6 = 1:4		Pop noise is generated when V <sub>CC</sub> is ON

Note: If recommended value is not used.

## Maximum Ratings (Ta = 25°C)

Characteristics	Symbol	Rating	Unit
Peak supply voltage (0.2 s)	V <sub>CC (surge)</sub>	50	V
DC supply voltage	V <sub>CC (DC)</sub>	28	V
Operation supply voltage	V <sub>CC (opr)</sub>	18	V
Output current (peak)	I <sub>O (peak)</sub>	9	A
Power dissipation	P <sub>D (Note 2)</sub>	125	W
Operation temperature	T <sub>opr</sub>	-40 to 85	°C
Storage temperature	T <sub>stg</sub>	-55 to 150	°C

Note 2: Package thermal resistance  $\theta_{j-T} = 1^\circ\text{C/W}$  (typ.) (Ta = 25°C, with infinite heat sink)

The absolute maximum ratings of a semiconductor device are a set of specified parameter values, which must not be exceeded during operation, even for an instant. If any of these rating would be exceeded during operation, the device electrical characteristics may be irreparably altered and the reliability and lifetime of the device can no longer be guaranteed. Moreover, these operations with exceeded ratings may cause break down, damage and/or degradation to any other equipment. Applications using the device should be designed such that each maximum rating will never be exceeded in any operating conditions. Before using, creating and/or producing designs, refer to and comply with the precautions and conditions set forth in this documents.

## Electrical Characteristics

(unless otherwise specified, V<sub>CC</sub> = 13.2 V, f = 1 kHz, R<sub>L</sub> = 4 Ω, Ta = 25°C)

Characteristics	Symbol	Test Circuit	Test Condition	Min	Typ.	Max	Unit
Quiescent current	I <sub>CCQ</sub>	—	V <sub>IN</sub> = 0	—	170	340	mA
Output power	P <sub>OUT MAX (1)</sub>	—	V <sub>CC</sub> = 14.4 V, max POWER	—	43	—	W
	P <sub>OUT MAX (2)</sub>	—	V <sub>CC</sub> = 13.7 V, max POWER	—	39	—	
	P <sub>OUT (1)</sub>	—	V <sub>CC</sub> = 14.4 V, THD = 10%	—	26	—	
	P <sub>OUT (2)</sub>	—	THD = 10%	21	23	—	
Total harmonic distortion	THD	—	P <sub>OUT</sub> = 5 W	—	0.015	0.15	%
Voltage gain	G <sub>V</sub>	—	V <sub>OUT</sub> = 0.775 V <sub>rms</sub>	32	34	36	dB
Voltage gain ratio	ΔG <sub>V</sub>	—	V <sub>OUT</sub> = 0.775 V <sub>rms</sub>	-1.0	0	1.0	dB
Output noise voltage	V <sub>NO (1)</sub>	—	R <sub>g</sub> = 0 Ω, DIN45405	—	160	—	μV <sub>rms</sub>
	V <sub>NO (2)</sub>	—	R <sub>g</sub> = 0 Ω, BW = 20 Hz~20 kHz	—	180	300	
Ripple rejection ratio	R.R.	—	f <sub>rip</sub> = 100 Hz, R <sub>g</sub> = 620 Ω V <sub>rip</sub> = 0.775 V <sub>rms</sub>	40	50	—	dB
Cross talk	C.T.	—	R <sub>g</sub> = 620 Ω V <sub>OUT</sub> = 0.775 V <sub>rms</sub>	—	60	—	dB
Output offset voltage	V <sub>OFFSET</sub>	—	—	(-150)	0	(150)	mV
Input resistance	R <sub>IN</sub>	—	—	—	30	—	kΩ
Standby current	I <sub>SB</sub>	—	Standby condition	—	2	10	μA
Standby control voltage	V <sub>SB H</sub>	—	POWER: ON	3.5	—	6.0	V
	V <sub>SB L</sub>	—	POWER: OFF	0	—	1.5	
Mute control voltage	V <sub>M H</sub>	—	MUTE: OFF	3.0	—	6.0	V
	V <sub>M L</sub>	—	MUTE: ON, R <sub>1</sub> = 47 kΩ	0	—	0.5	
Mute attenuation	ATT M	—	MUTE: ON V <sub>OUT</sub> = 7.75 V <sub>rms</sub> → Mute: OFF	85	100	—	dB



## Offset detection

Detection threshold voltage	Voff-set	—	Rpull-up = 47 kΩ, +V = 5.0V Based on output DC voltage	±1.0	±1.5	±2.0	V
-----------------------------	----------	---	---	------	------	------	---

## Test Circuit

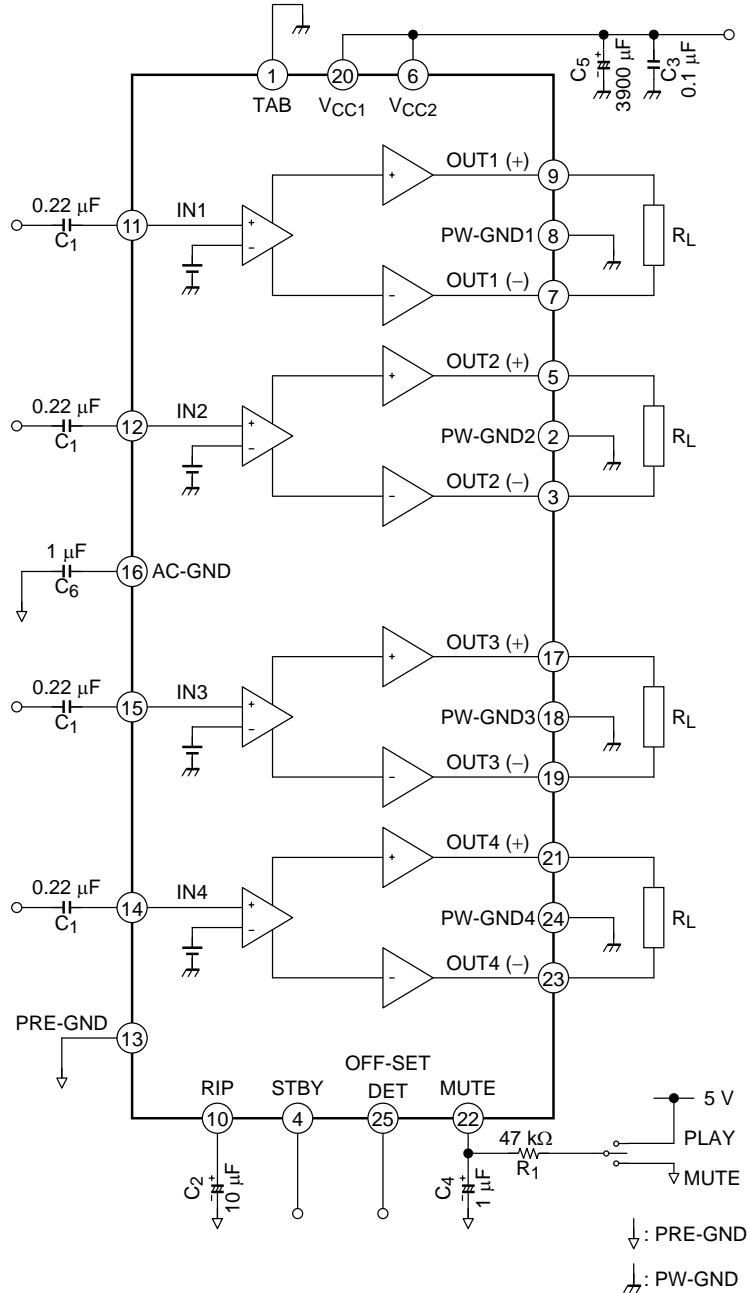

Components in the test circuits are only used to obtain and confirm the device characteristics.  
 These components and circuits do not warrant to prevent the application equipment from malfunction or failure.

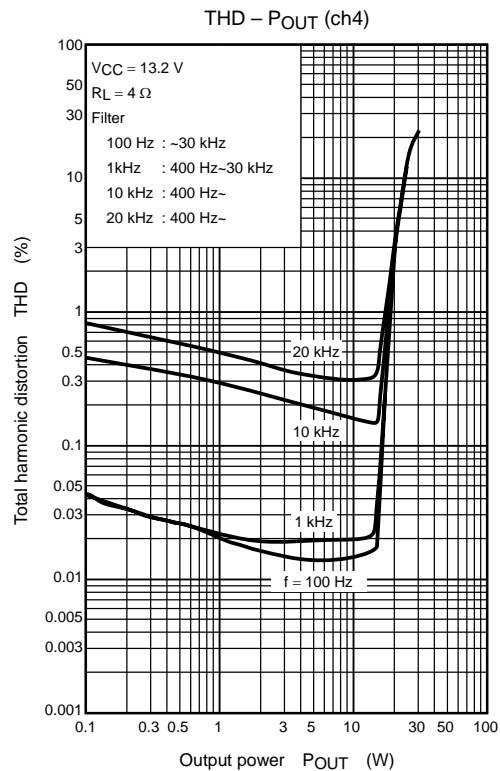
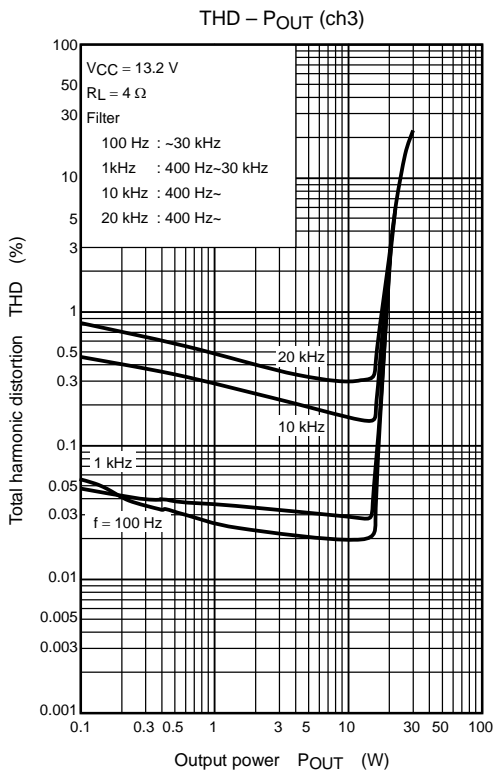
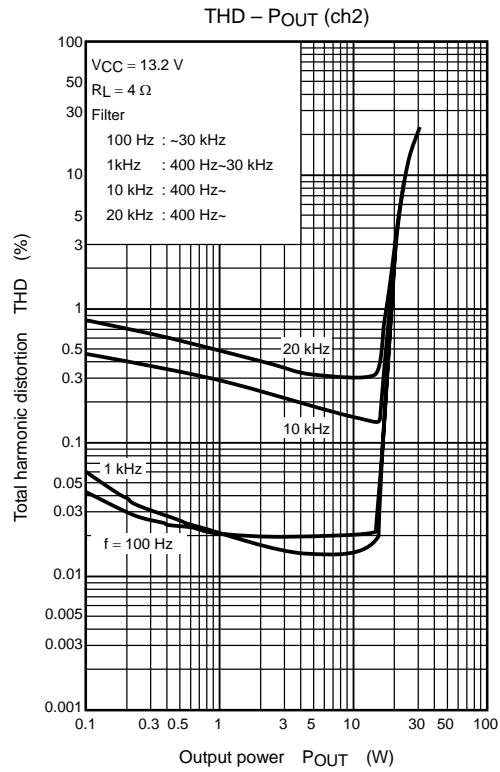
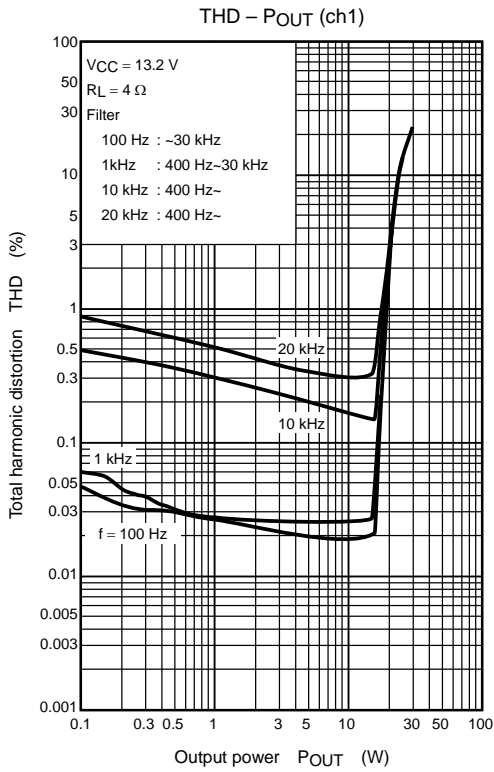

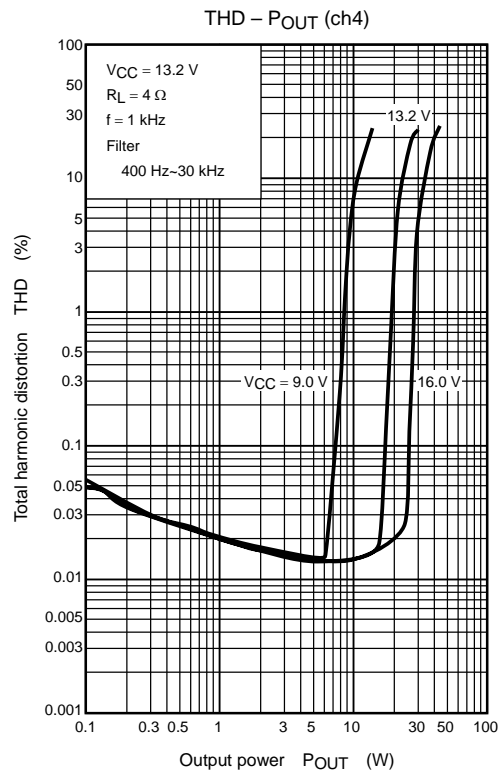
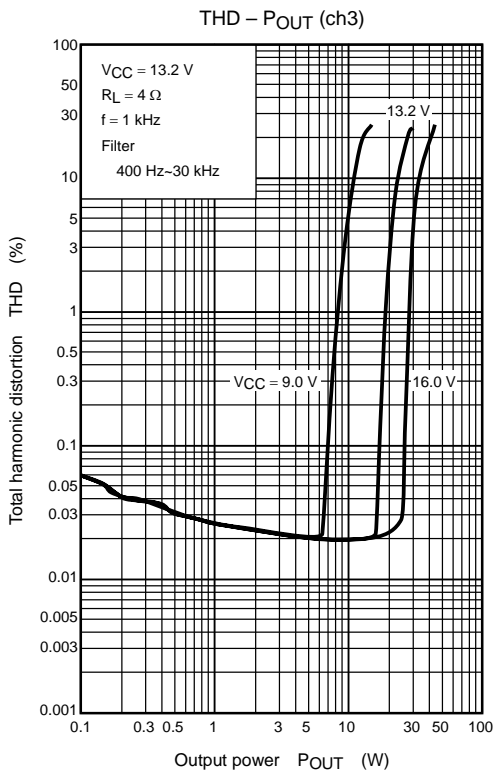
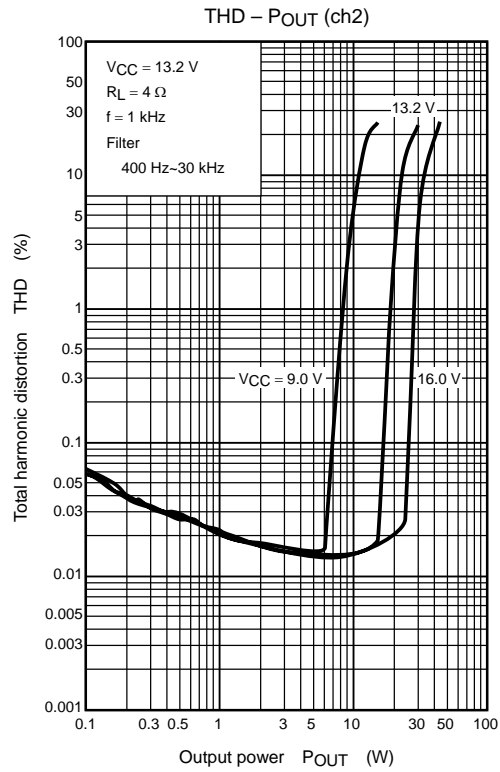
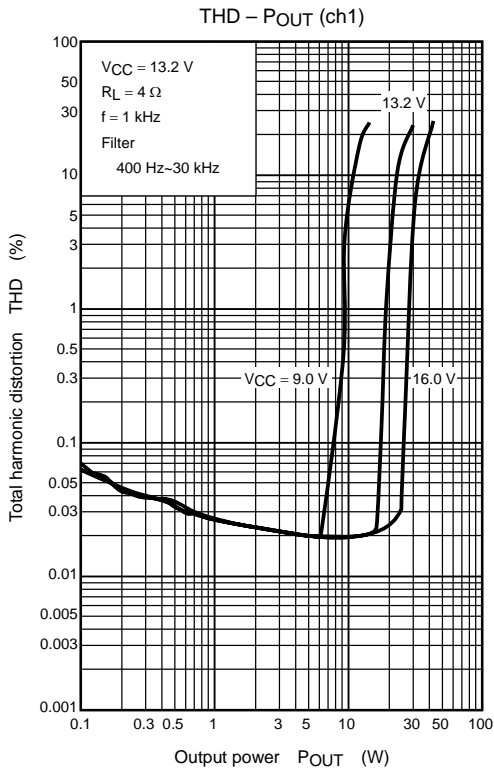

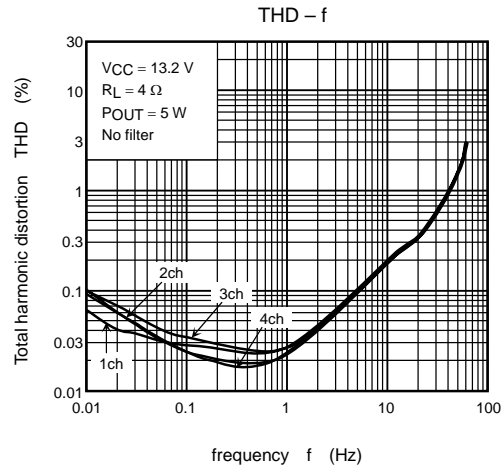
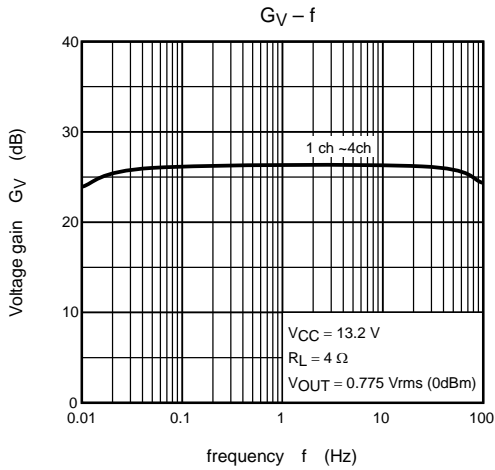
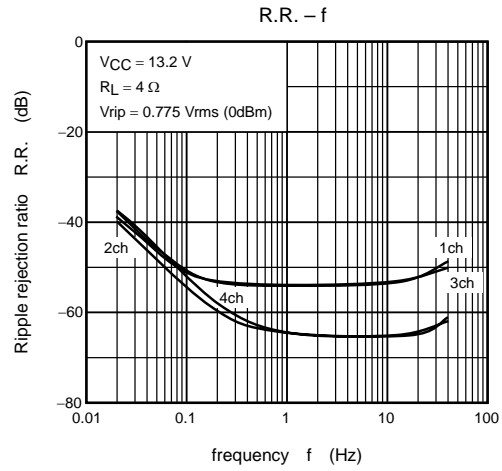
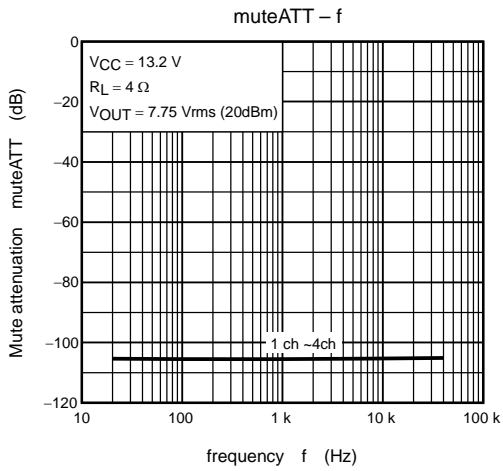

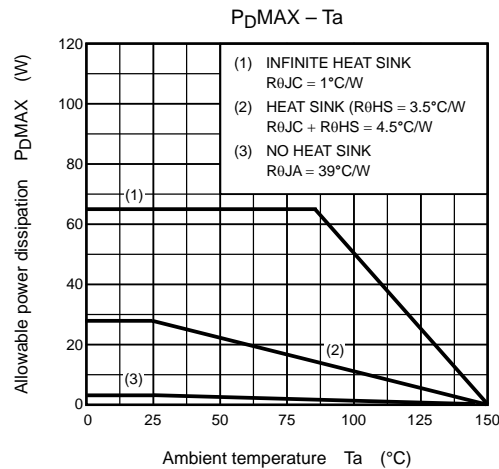
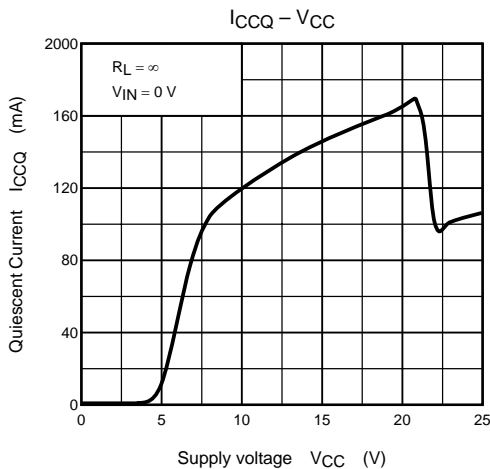
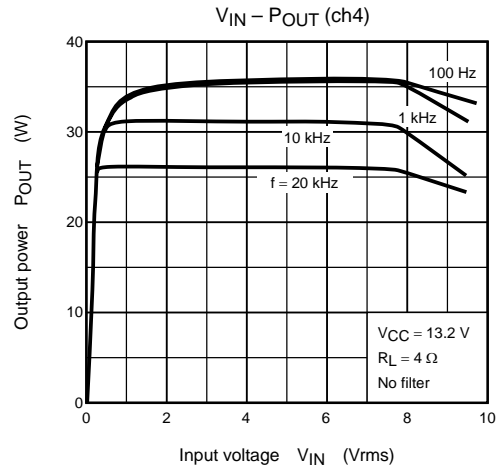
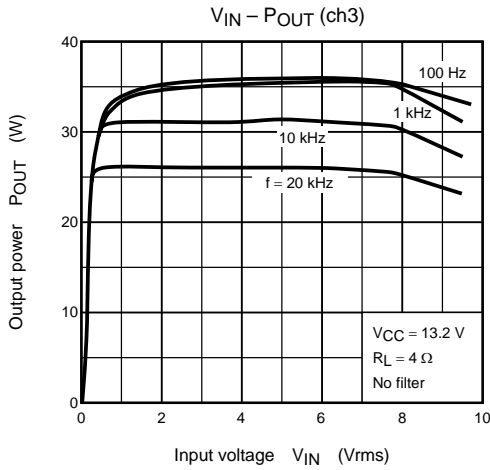
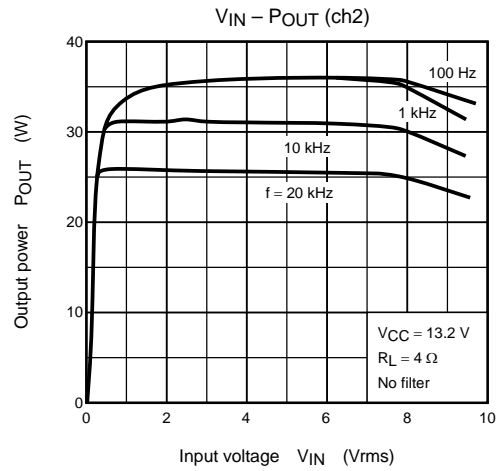
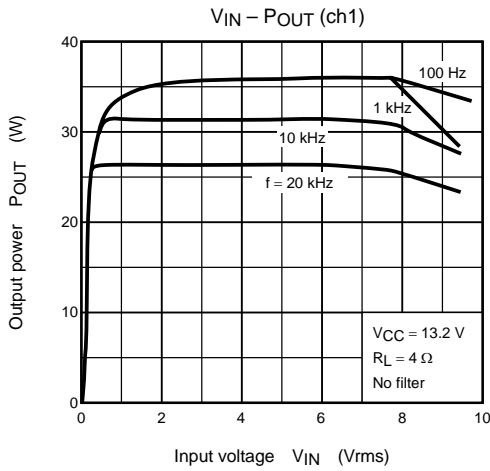

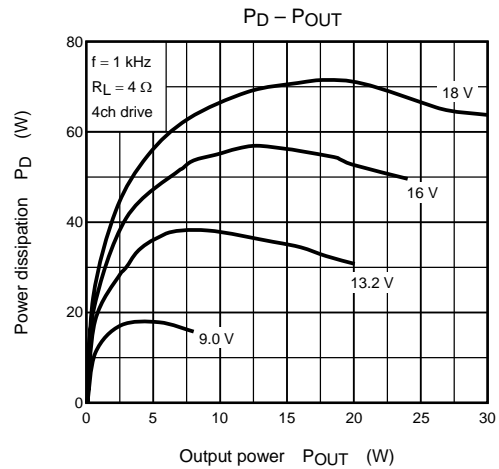
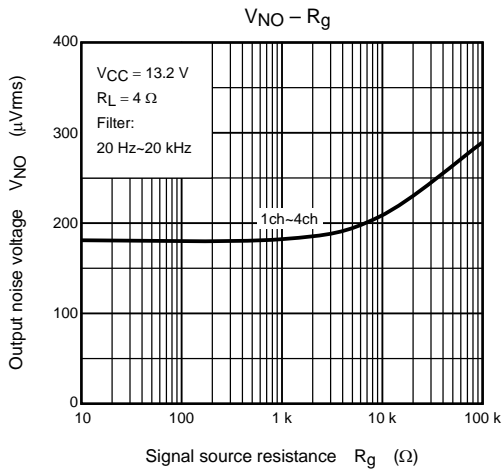
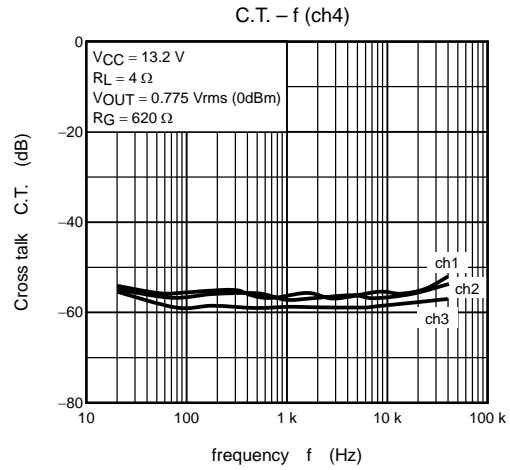
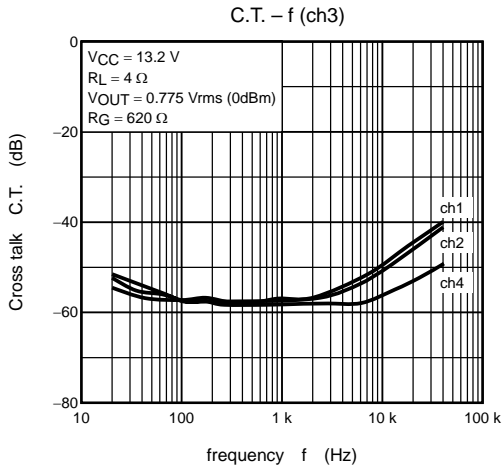
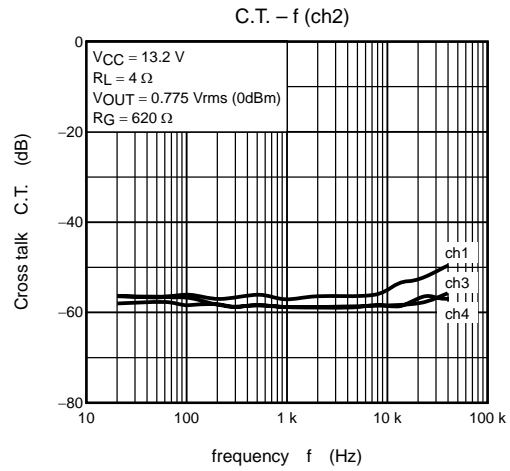
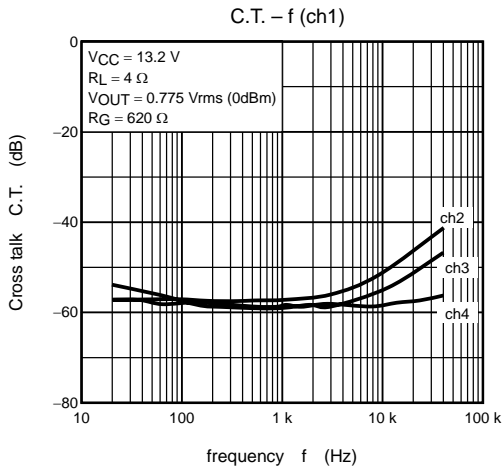

## Package Dimensions

HZIP25-P-1.00F

Unit: mm

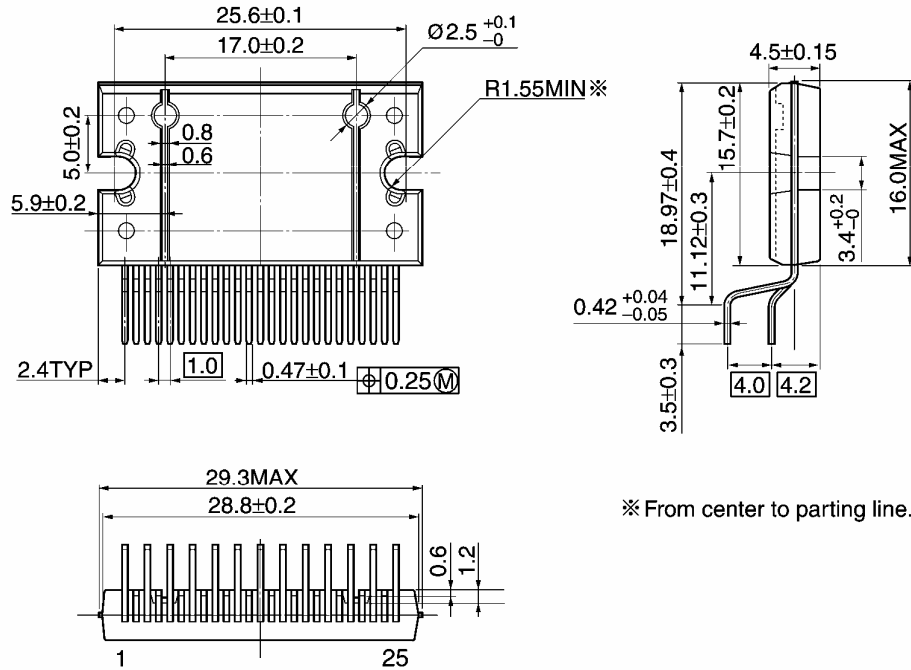

※ From center to parting line.

Weight: 7.7 g (typ.)

About solderability, following conditions were confirmed

- Solderability
  - (1) Use of Sn-63Pb solder Bath
    - solder bath temperature = 230°C
    - dipping time = 5 seconds
    - the number of times = once
    - use of R-type flux
  - (2) Use of Sn-3.0Ag-0.5Cu solder Bath
    - solder bath temperature = 245°C
    - dipping time = 5 seconds
    - the number of times = once
    - use of R-type flux

## RESTRICTIONS ON PRODUCT USE

030619EBF

- The information contained herein is subject to change without notice.
- The information contained herein is presented only as a guide for the applications of our products. No responsibility is assumed by TOSHIBA for any infringements of patents or other rights of the third parties which may result from its use. No license is granted by implication or otherwise under any patent or patent rights of TOSHIBA or others.
- TOSHIBA is continually working to improve the quality and reliability of its products. Nevertheless, semiconductor devices in general can malfunction or fail due to their inherent electrical sensitivity and vulnerability to physical stress. It is the responsibility of the buyer, when utilizing TOSHIBA products, to comply with the standards of safety in making a safe design for the entire system, and to avoid situations in which a malfunction or failure of such TOSHIBA products could cause loss of human life, bodily injury or damage to property.  
In developing your designs, please ensure that TOSHIBA products are used within specified operating ranges as set forth in the most recent TOSHIBA products specifications. Also, please keep in mind the precautions and conditions set forth in the "Handling Guide for Semiconductor Devices," or "TOSHIBA Semiconductor Reliability Handbook" etc..
- The TOSHIBA products listed in this document are intended for usage in general electronics applications (computer, personal equipment, office equipment, measuring equipment, industrial robotics, domestic appliances, etc.). These TOSHIBA products are neither intended nor warranted for usage in equipment that requires extraordinarily high quality and/or reliability or a malfunction or failure of which may cause loss of human life or bodily injury ("Unintended Usage"). Unintended Usage include atomic energy control instruments, airplane or spaceship instruments, transportation instruments, traffic signal instruments, combustion control instruments, medical instruments, all types of safety devices, etc.. Unintended Usage of TOSHIBA products listed in this document shall be made at the customer's own risk.
- The products described in this document are subject to the foreign exchange and foreign trade laws.
- TOSHIBA products should not be embedded to the downstream products which are prohibited to be produced and sold, under any law and regulations.
- This product generates heat during normal operation. However, substandard performance or malfunction may cause the product and its peripherals to reach abnormally high temperatures.  
The product is often the final stage (the external output stage) of a circuit. Substandard performance or malfunction of the destination device to which the circuit supplies output may cause damage to the circuit or to the product.